

LUFFING JIB TOWER CRANE









**Specifications:**

- ▶ Max jib length: 60,00 m
- ▶ Capacity at max length: 5,50 t
- ▶ Max capacity: 24,00 t

WORKS FOR YOU.™

KEY

Legenda · Zeichenerklärung · Légende · Leyenda · Legenda · Условные обозначения

	Hoisting · Sollevamento · Heben · Levage · Elevación · Elevação · Подъем
	Trolleying · Traslazione carrello · Katzfahren · Distribution · Distribución · Distribuição · Передвижение каретки
	Slewing · Rotazione · Schwenken · Orientation · Orientació · Giro · Поворот
	Luffing · Brandeggio · Ausleger-Einziehen · Relevage · Elevación de pluma · Lança basculante · Наклон стрелы
	Travelling · Traslazione · Schienenfahren · Translation · Traslación · Móvel · Передвижение
	Directive on noise level · Direttiva sul livello acustico · Richtlinie für den Schall-Leistungspegel · Directive sur le niveau acoustique · Directiva sobre el nivel acustico · Directiva sobre nivel de ruidos · Директива по уровню шума
	Consult us · Consultateci · Auf Anfrage · Nous consulter · Consultarnos · Consulte-nos · Проконсультироваться с нами
	Power requirements · Potenza totale richiesta · Geforderte Stromstärke · Puissance totale nécessaire · Potencia necesaria · Requisitos de energia · Требования по питанию
	Power supply · Alimentazione · Stromversorgung · Alimentation · Alimentación · Fonte de alimentação · Питание
	In service · In servizio · In Betrieb · En service · En servicio · Em serviço · При работе
	Out of service · Fuori servizio · Außer Betrieb · Hors service · Fuera de servicio · Fora de serviço · В режиме простоя
	Max. under hook height · Altezza max. sotto gancio · Höchste Hakenhöhe · Hauteur maxi. sous crochet · Maxima altura bajo gancho · Alt. máx. sob o gancho · Макс высота крюка
	Jib · Braccio · Ausleger · Flèche · Pluma · Lança · Стрела
	Without load, without ballast, max. jib and max. height · A vuoto, senza zavorra, braccio max., altezza max. · Ohne Last und Ballast, mit Maximalausleger und Maximalhöhe · A vide, sans lest, avec flèche et hauteur maximum · Sin carga, sin lastre, con pluma y altura máxima · Sem carga, sem lastro, lança máxima, altura máxima · Без груза, без балласта, на макс. Длине вспомогательной стрелы и макс. Высоте
	Counterweight · Zavorra controbraccio · Gegengewicht · Lest de contre-flèche · Lastre de contra flecha · Contrapeso · Противовес
C25	EN 14439-C25 · EN 14439 - C25 · EN14439 - C25 · EN 14439 - C25 · EN 14439 - C25 · EN 14439 - C25 · EN14439 - C25

CONTENTS

CTL 430-24

Indice · Inhalt · Contenu · Contenido · Sumário · Содержание

Page · Seite · Page · Página · Pagina · Página · Страница:

Load Diagram · Diagramma di portata · Lastkurven · Courbes de charges · Curvas de cargas · Diagrama de carga · Диаграмма грузоподъёмности	4
Tower · Torre · Turm · Tour · Torre · Torre · Башня	6
Mechanisms · Meccanismi · Antriebe · Mécanismes · Mecanismos · Mecanismo · Механизм	9
Transportation · Trasporto · Transport · Transport · Transporte · Transporte · Транспортировка	10

LOAD DIAGRAM

Diagramma di portata · Lastkurven · Courbes de charges · Curvas de cargas · Diagrama de carga · Диаграмма грузоподъёмности

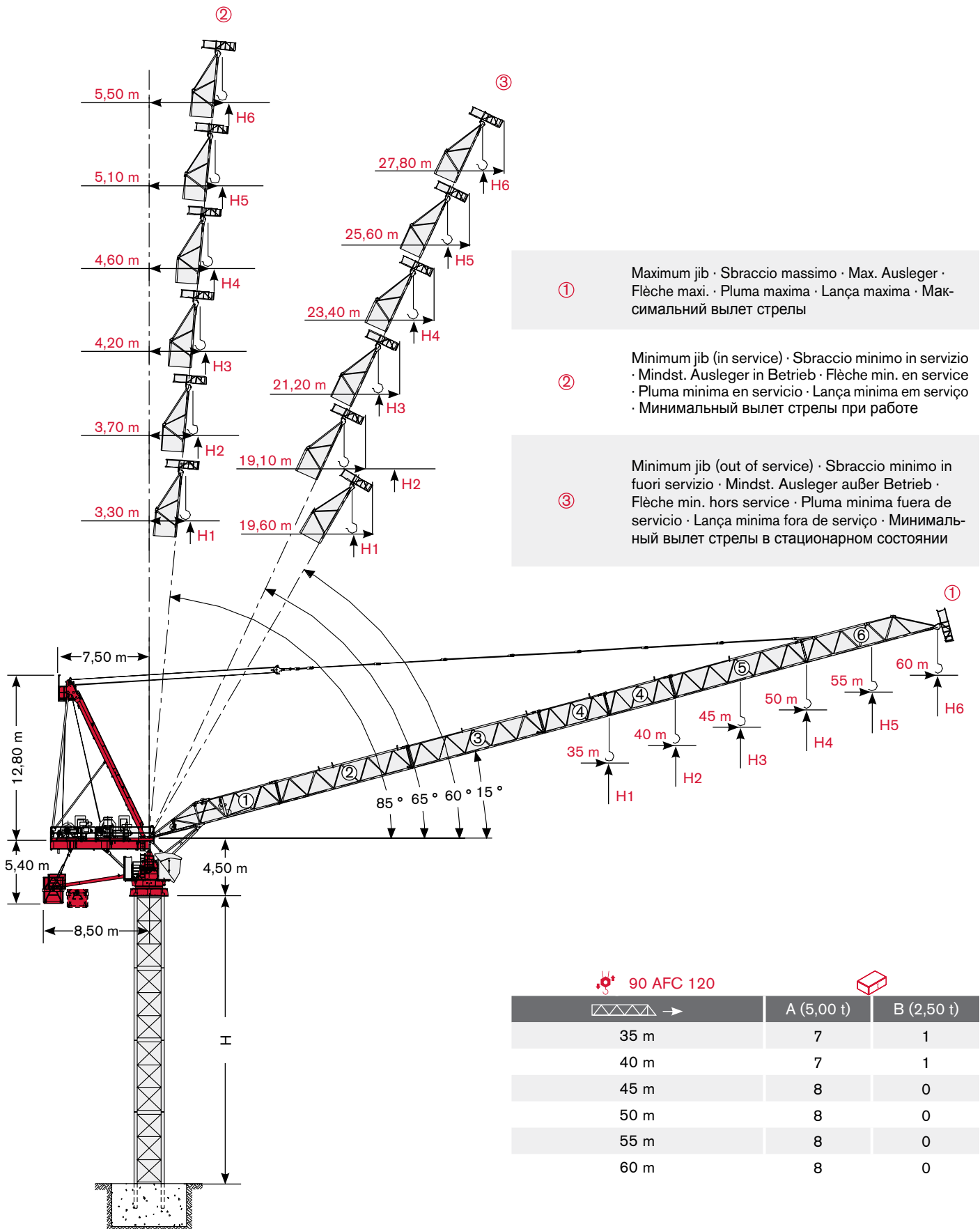

Load Diagram · Diagramma di portata · Lastkurven · Courbes de charges · Curvas de cargas · Diagrama de carga · Схема нагрузок

				10 m	15 m	20 m	25 m	30 m	35 m	40 m	45 m	50 m	55 m	60 m
	12 t →	28,50 m	t	12,00	12,00	12,00	12,00	11,42	9,72	8,46	7,47	6,68	6,03	5,50
	12 t →	32,80 m	t	12,00	12,00	12,00	12,00	12,00	11,24	9,78	8,64	7,74	7,00	
	18 t →	21,90 m	t	18,00	18,00	18,00	15,71	12,99	11,04	9,58	8,45	7,54	6,80	
	12 t →	37,90 m	t	12,00	12,00	12,00	12,00	12,00	12,00	11,35	10,04	9,00		
	18 t →	25,00 m	t	18,00	18,00	18,00	18,00	14,89	12,64	10,96	9,64	8,60	*	
	24 t →	19,00 m	t	24,00	24,00	22,76	18,04	14,89	12,64	10,96	9,64	8,60		
	12 t →	39,90 m	t	12,00	12,00	12,00	12,00	12,00	12,00	12,00	10,60			
	18 t →	26,30 m	t	18,00	18,00	18,00	18,00	15,72	13,35	11,58	10,20	*		
	24 t →	20,00 m	t	24,00	24,00	24,00	19,03	15,72	13,35	11,58	10,20			
	12 t →	40,00 m	t	12,00	12,00	12,00	12,00	12,00	12,00	12,00				
	18 t →	27,20 m	t	18,00	18,00	18,00	18,00	16,28	13,83	12,00	*			
	24 t →	20,60 m	t	24,00	24,00	24,00	19,70	16,28	13,83	12,00				
	12 t →	35,00 m	t	12,00	12,00	12,00	12,00	12,00	12,00					
	18 t →	28,10 m	t	18,00	18,00	18,00	18,00	16,82	14,30	*				
	24 t →	21,30 m	t	24,00	24,00	24,00	20,35	16,82	14,30					

* = + 200 kg [- 50 m - 45 m - 40 m - 35 m]

Load diagram not consider rope weight: $p = 1.6 \text{ Kg/m}$ · Diagramma di carico senza peso fune di sollevamento: $p = 1.6 \text{ kg/m}$ · Lastkurven beinhalten nicht das Eigengewicht des Hubseils: $p = 1,6 \text{ Kg/m}$ · La courbe de charge ne tient pas compte du poids du câble $p = 1,6 \text{ kg/m}$ · La tabla de cargas no incluye el peso del cable: $p = 1,6 \text{ kg/m}$ · Diagrama de carga não considera o peso da corda: $p = 1,6 \text{ kg / m}$ · Грузовысотная характеристика составлена без учета веса каната: $p = 1.6 \text{ кг/м}$

Jib and Tower Height Configurations · Configurazioni torre e braccio · Ausleger- und Turmkonfigurationen · Configurations de la flèche et du mât · Configuraciones de pluma y torre · Configuração de lança e altura de torre · Конфигурация башни и стрелы

35 m	1 + 2 + 4 + 6
40 m	1 + 2 + 3 + 6
45 m	1 + 2 + 3 + 4 + 6
50 m	1 + 2 + 3 + 5 + 6
55 m	1 + 2 + 3 + 4 + 5 + 6
60 m	1 + 2 + 3 + 4 + 4 + 5 + 6

	H		
	①	②	③
H1	H + 10,30 m	H + 34,90 m	H + 30,20 m
H2	H + 11,70 m	H + 40,10 m	H + 36,40 m
H3	H + 13,00 m	H + 45,30 m	H + 41,10 m
H4	H + 14,40 m	H + 50,40 m	H + 45,70 m
H5	H + 15,70 m	H + 55,60 m	H + 50,40 m
H6	H + 17,00 m	H + 60,70 m	H + 55,10 m

TOWER

Torre · Turm · Tour · Torre · Torre · Башня

Standard Configurations · Installazioni Standard · Standardkonfiguration · Standard Implantations · Implantaciones Standard · Configuração padrão · Стандартная конфигурация крана

HD23

Tower: HD23 & Basement: FP1

	●	◊
R1	-1750 kN	-1900 kN
R2	0 kN	0 kN
	1120 kN	

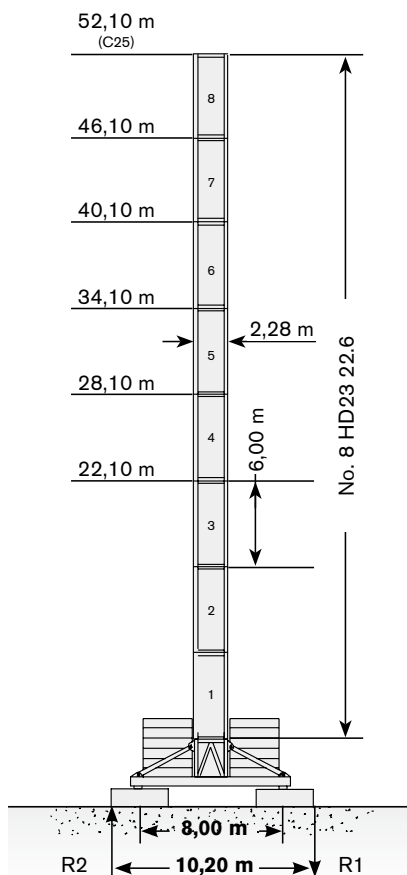

→	max. H (m)	
	FEM 1005 C25	FEM 1001
		
35 m	52,10	52,10
40 m	52,10	46,10
45 m	46,10	46,10
50 m	46,10	46,10
55 m	46,10	40,10
60 m	40,10	40,10

Tower: HD23 & Basement: T1

	●	◊
R1	-1750 kN	-1900 kN
R2	0 kN	0 kN
	1120 kN	

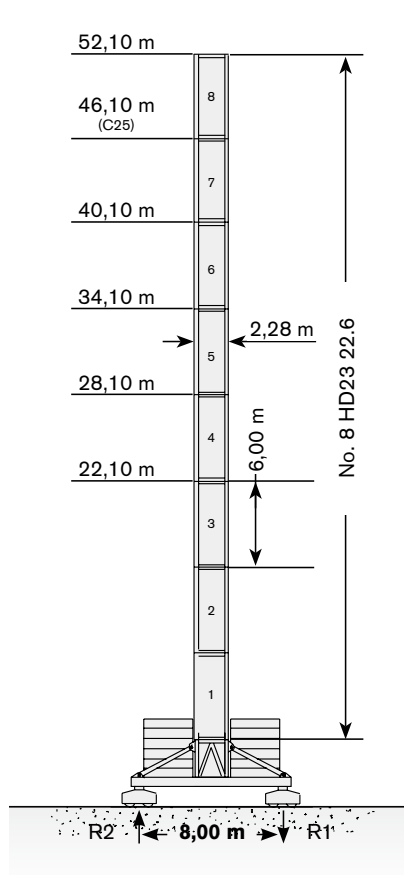

→	max. H (m)	
	FEM 1005 C25	FEM 1001
		
35 m	52,10	52,10
40 m	46,10	46,10
45 m	46,10	46,10
50 m	46,10	46,10
55 m	40,10	40,10
60 m	40,10	40,10

Tower: HD23 & Basement: R2

	●	◊
R1	-3350 kN	-4200 kN
R2	2500 kN	3550 kN
	970 kN	

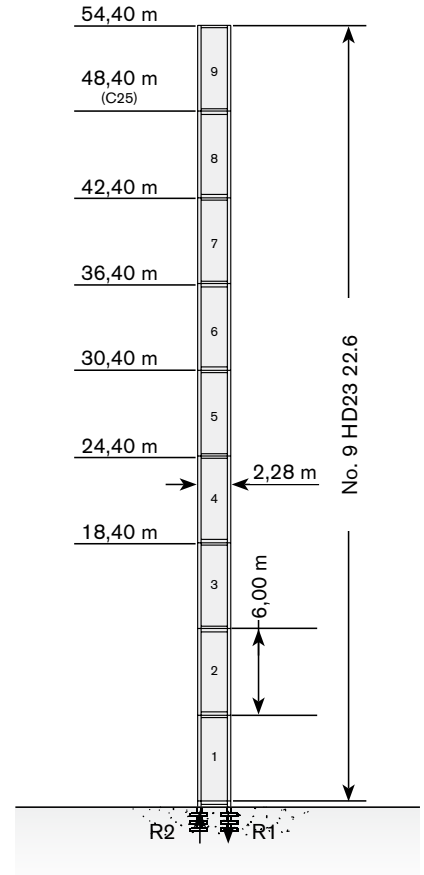



→	max. H (m)	
	FEM 1005 C25	FEM 1001
		
35 m	48,40	54,40
40 m	48,40	48,40
45 m	48,40	48,40
50 m	42,40	48,40
55 m	42,40	42,40
60 m	42,40	42,40

Tower height · Altezza torre · Turmhohe · Hauteur mat · Altura torre · Altura torre · Высота башни

Tower: HD23 & Basemet: FP3

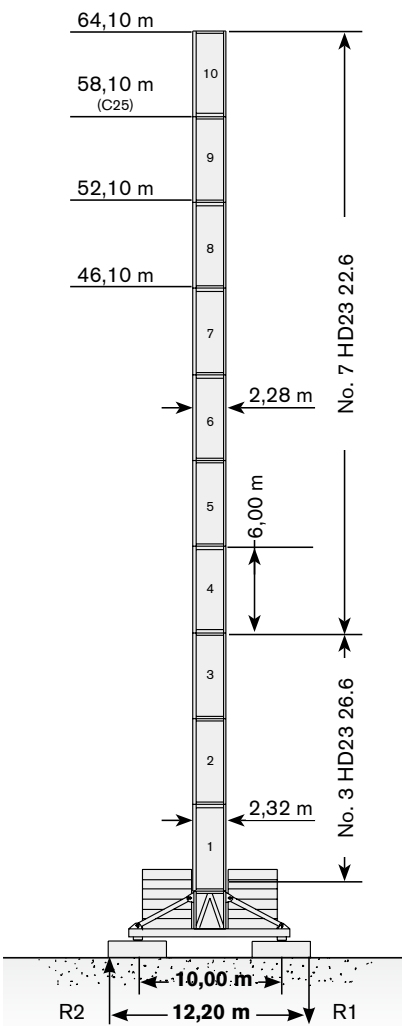
	●	◊
R1	-1750 kN	-1914 kN
R2	0 kN	0 kN
	1370 kN	



→	max. H (m)	
	FEM 1005 C25	FEM 1001
		
35 m	64,10	64,10
40 m	58,10	58,10
45 m	58,10	58,10
50 m	58,10	58,10
55 m	52,10	52,10
60 m	52,10	52,10

Tower: HD23 & Basemet: R3

	●	◊
R1	-3000 kN	-5100 kN
R2	2180 kN	4400 kN
	1050 kN	

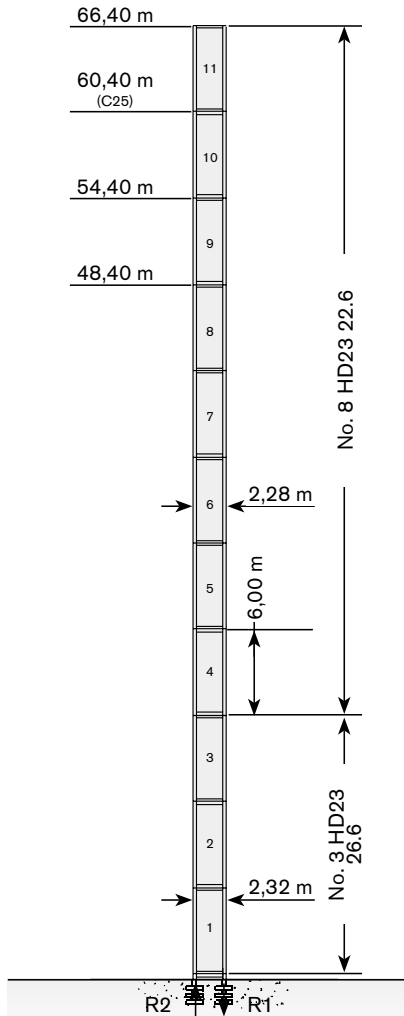

→	max. H (m)	
	FEM 1005 C25	FEM 1001
		
35 m	60,40	66,40
40 m	60,40	60,40
45 m	54,40	60,40
50 m	54,40	60,40
55 m	54,40	54,40
60 m	48,40	54,40

Tower: HD23 & Basemet: T3

	●	◊
R1	-1750 kN	-1915 kN
R2	0 kN	0 kN
	1370 kN	

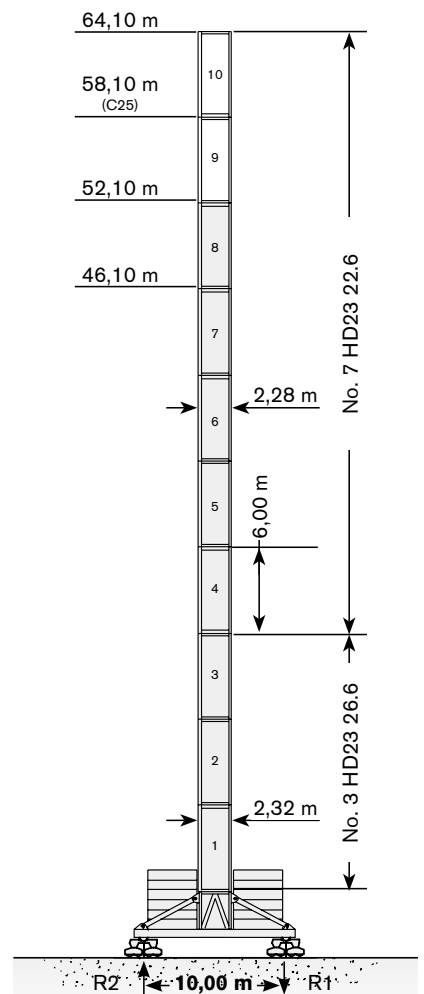

→	max. H (m)	
	FEM 1005 C25	FEM 1001
		
35 m	64,10	64,10
40 m	58,10	64,10
45 m	58,10	64,10
50 m	58,10	58,10
55 m	52,10	58,10
60 m	52,10	58,10

Different heights and tower combinations are available; please consult us · Altezze diverse e combinazioni di torre sono disponibili; consultateci · Andere Höhen und Turmkombinationen auf Anfrage · Différentes hauteurs et combinaisons de tour sont disponibles; nous consulter · Hay diferentes alturas y combinaciones de torre disponibles. Consúltenos · Diferentes alturas e combinações de torres disponíveis; fale conosco · Возможны другие сочетания высоты и конфигурации башни; проконсультируйтесь с нами

TOWER

Torre · Turm · Tour · Torre · Torre · Башня

Standard Configurations · Installazioni Standard · Standardkonfiguration · Standard Implantations · Implantaciones Standard · Configuração padrão · Стандартная конфигурация крана

HD23

Tower: HD23 & Basement: R4

	●	◊
R1	-4027 kN	-6597 kN
R2	3042 kN	5815 kN
	1238 kN	

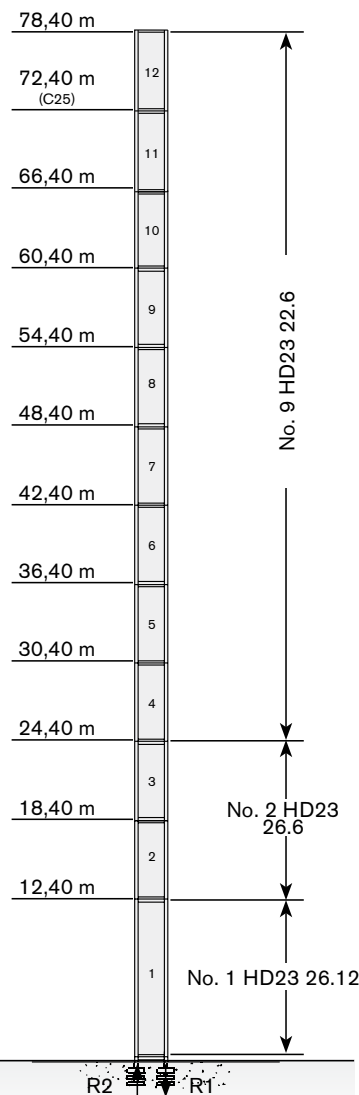

→	max. H (m)	
	FEM 1005 C25	FEM 1001
		
35 m	72,40	78,40
40 m	66,40	72,40
45 m	66,40	72,40
50 m	66,40	72,40
55 m	60,40	66,40
60 m	60,40	66,40

Other configurations · Altre Installazioni · Aufstellmöglichkeiten · Autres Implantations · Otras Implantaciones · Outras configurações · Другие конфигурации

Bottom climbing crane · Gru climbing · Kletterkran im Gebäude · Télescopage sur dalles · Telescopage grúa trepadora · Guindaste automontante interno · **Самоподъемный кран**

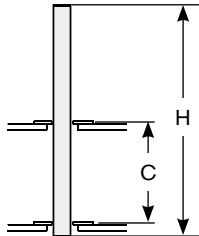

Tower: HD23-22

	C	H
35 m	13,00 m	48,00 m
	15,00 m	54,00 m
	16,00 m	54,00 m
40 m	13,00 m	42,00 m
	15,00 m	48,00 m
	16,00 m	48,00 m
45 m	13,00 m	42,00 m
	15,00 m	48,00 m
	16,00 m	48,00 m
50 m	13,00 m	42,00 m
	15,00 m	48,00 m
	16,00 m	48,00 m
55 m	13,00 m	36,00 m
	15,00 m	42,00 m
	16,00 m	42,00 m
60 m	13,00 m	36,00 m
	15,00 m	42,00 m
	16,00 m	42,00 m

Crane tied to the structure · Gru ancorata · Geankerter Kran · Grue ancrée · Grúa anclada · Guindaste ancorado na estrutura · **Кран, крепящийся к сооружению**

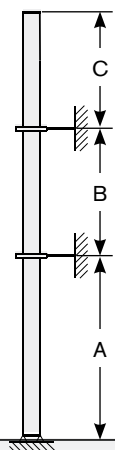

Tower: HD23-22

	A min/max	B min/max	C max
35 m	36 m/48 m	24 m/36 m	30 m
40 m	30 m/42 m	24 m/36 m	30 m
45 m	30 m/42 m	24 m/36 m	30 m
50 m	30 m/42 m	24 m/36 m	26 m
55 m	30 m/36 m	24 m/36 m	24 m
60 m	30 m/36 m	24 m/36 m	24 m

MECHANISMS





Meccanismi · Antriebe · Mécanismes · Mecanismos · Mecanismo · Механизм

Power supply · Alimentazione · Stromversorgung · Alimentation · Suministro eléctrico · Requisitos de energia · Требования по питанию

	90 AFC 120 R - LFC 80	 224 kVA*	 400V - 50Hz / 460V - 60Hz	 2000/14/CE modificata
---	-----------------------	--	---	---

* Average consumption · Consumo medio · Durchschnittsverbrauch · Consommation moyenne · Consumo medio · Consumo médio · Среднее потребление



Hoisting · Sollevamento · Heben · Levage · Elevación · Elevação · Подъем

		t	m/min	kW		
	90 AFC 120 R00 90 AFC 120 R01 (vector)		12	0 → 35	90	1030 m
			9	0 → 43		
			6	0 → 59		
			3	0 → 104		
			1,35	0 → 160		
			18	0 → 23		
			13,5	0 → 29		
			9	0 → 39		
			4,5	0 → 69		
			2	0 → 107		
			24	0 → 17		
			18	0 → 22		
			12	0 → 29		
			6	0 → 52		
			2,7	0 → 80		

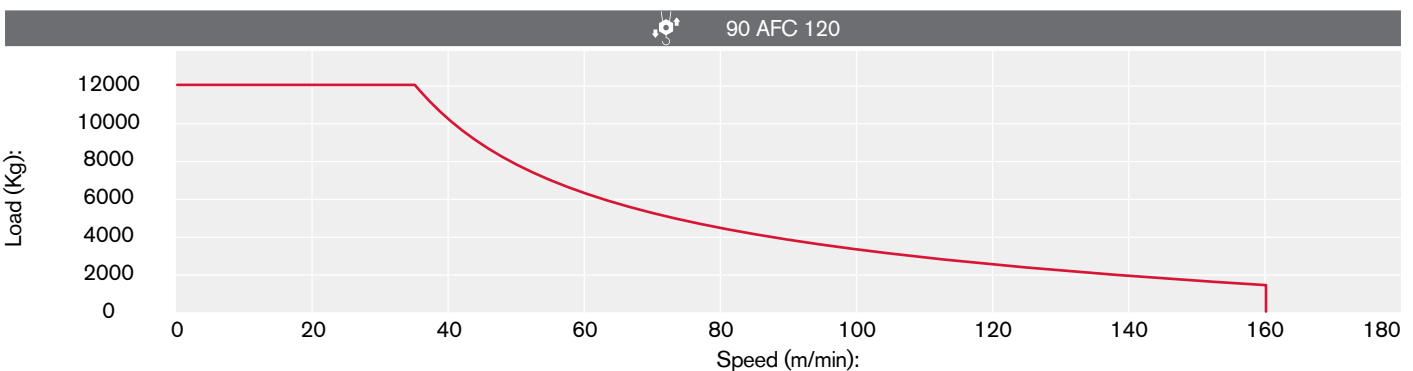
Hoisting Speed · Velocità di Sollevamento · Heben Geschwindigkeit · Vitesse de Levage · Velocidad de Elevación · Velocidade de içamento · Скорость подъема











Additional Specifications · Altre movimentazioni · Weitere Leistungsdaten · Spécifications additionnelles · Otras prestaciones · Especificações adicionais · Дополнительные спецификации

	LFC 80 (vector)	2 min	80 kW
	RCC 2 2 132M	0 → 0,64 r.p.m.	2 x 14,4 kW



Packing list





Undercarriage

CTL 430-24	DESCRIPTION · DESCRIZIONE · BESCHREIBUNG · DESCRIPTION · DESCRIPCION · DESCRIÇÃO · ОПИСАНИЕ	LENGTH · LUNGHEZZA · LÄNGE · LONGUEUR · LONGITUD · COMPRIMENTO · ДЛИНА	WIDTH · LARGHEZZA · BREITE · LARGEUR · ANCHURA · LARGURA · ШИРИНА	HEIGHT · ALTEZZA · HÖHE · HAUTEUR · ALTURA · ALTURA · · ВЬСОТА	QUANTITY · QUANTITÀ · MENGE · QUANTITÉ · · CANTIDAD · QUANTIDADE · КОЛИЧЕСТВО	WEIGHT · PESO · GEWICHT · POIDS · PESO · PESO · BEC
	8x8 m UNDERCARRIAGE STRUT MOUNTING TOWER SEC- TION	2,90 m	2,90 m	2,90 m	1	9150 kg
	8x8 m UNDERCARRIAGE STRUT	4,30 m	0,30 m	2,25 m	4	1820 kg
	8x8 m UNDERCARRIAGE INTERNAL BEAM	4,00 m	0,16 m	0,33 m	4	210 kg
	8x8 m UNDERCARRIAGE EXTERNAL BEAM	5,96 m	0,30 m	0,33 m	4	626 kg
	10x10 m) UNDERCARRIAGE STRUT MOUNTING TOWER SECTION	3,00 m	3,00 m	3,10 m	1	10450 kg
	10x10 m LEFT + RIGHT UNDERCARRIAGE STRUT	5,70 m	2,60 m	0,70 m	2 left + 2 right	3825 kg
	CROSSBEAM FOR TRAVELLING 10x10 m UNDERCARRIAGE	7,00 m	2,20 m	0,40 m	2	2030 kg
	10x10 m UNDERCARRIAGE ELECTRICAL BOX SUPPORT PLATFORM FOR TVF 4RT 4M9 TRAVELLING DRIVE UNIT	5,70 m	2,20 m	2,40 m	1	1300 kg
	10x10 m UNDERCARRIAGE ELECTRICAL BOX SUPPORT PLATFORM FOR TSR 4RG 4M8 TRAVELLING DRIVE UNIT	5,60 m	2,10 m	3,70 m	1	645 kg







TRANSPORTATION

Trasporto · Transport · Transport · Transporte · Transporte · Транспортировка

Tower

CTL 430-24	DESCRIPTION · DESCRIZIONE · BESCHREIBUNG · DESCRIPTION · DESCRIPCIÓN · DESCRIÇÃO · ОПИСАНИЕ	LENGTH · LUNGHEZZA · LÄNGE · LONGUEUR · LONGITUD · COMPRIMENTO · ДЛИНА	WIDTH · LARGHEZZA · BREITE · LARGEUR · ANCHURA · LARGURA · ШИРИНА	HEIGHT · ALTEZZA · HÖHE · HAUTEUR · ALTURA · ALTURA · · ВИСОТА	QUANTITY · QUANTITÀ · MENGE · QUANTITÉ · · CANTIDAD · QUANTIDADE · КОЛИЧЕСТВО	WEIGHT · PESO · GEWICHT · POIDS · PESO · PESO · ВЕС
	TOWER SECTION HD23 26.6	6,00 m	2,34 m	2,32 m	1	6300 kg*
	TOWER SECTION HD23 26.3	3,00 m	2,34 m	2,32 m	1	3658 kg
	TOWER SECTION HD23 22.6	6,00 m	2,28 m	2,29 m	1	4675 kg*
	TOWER SECTION HD23 22.3	3,00 m	2,29 m	2,28 m	1	2660 kg*
	COMPLETE SLEWING UNIT (3 DETACHABLE PIECES)	4,43 m	4,00 m	3,56 m	1	15810 kg

Upper Part

	LEVERAGE-A	5,52 m	1,89 m	0,73 m	1	1010 kg
	LEVERAGE FRAME RETAINER-A	1,36 m	1,79 m	0,14 m	1	143 kg
	FORKED MOBILE BALLAST BASKET LEVERAGE-B	7,83 m	2,37 m	0,40 m	1	730 kg
	MOBILE BALLAST BASKET	1,67 m	2,54 m	2,46 m	1	1130 kg
	LEVERAGE-C FOR SUPPORT BASKET	3,20 m	2,28 m	0,30 m	1	595 kg
	COUNTERJIB (frame retainer, platforms included without winches)	7,90 m	3,85 m	4,10 m	1	8870 kg

* inclusive of ladders, platforms and assembly equipment

CTL 430-24	DESCRIPTION · DESCRIZIONE · BESCHREIBUNG · DESCRIPTION · DESCRIPCIÓN · DESCRIÇÃO · ОПИСАНИЕ	LENGTH · LUNGHEZZA · LÄNGE · LONGUEUR · LONGITUD · COMPRIMENTO · ДЛИНА	WIDTH · LARGHEZZA · BREITE · LARGEUR · ANCHURA · LARGURA · ШИРИНА	HEIGHT · ALTEZZA · HÖHE · HAUTEUR · ALTURA · ALTURA · · ВЬСОТА	QUANTITY · QUANTITÀ · MENGE · QUANTITÉ · · CANTIDAD · QUANTIDADE · КОЛИЧЕСТВО	WEIGHT · PESO · GEWICHT · POIDS · PESO · PESO · ВЕС
	COUNTERJIB FRAME RETAINER	3,05 m	2,00 m	0,32 m	1	771 kg
	LUFFING WINCH 80 Kw (rope included)	2,47 m	2,11 m	2,00 m	1	4640 kg
	HOIST WINCH AFC120 90 Kw R00 Without brake option (rope included)	2,82 m	2,25 m	1,98 m	1	6100 kg
	HOIST WINCH AFC120 90 Kw R01 With brake option (rope included)	2,82 m	2,27 m	1,98 m	1	6490 kg
	COMPLETE A-FRAME UNIT	7,24 m	2,50 m	13,10 m	1	5950 kg
	JIB SECTION - 1	10,61 m	1,94 m	2,27 m	1	2960 kg
	JIB SECTION - 2	10,56 m	1,91 m	1,93 m	1	1449 kg
	JIB SECTION - 3	10,56 m	1,91 m	1,93 m	1	1441 kg
	JIB SECTION - 4	5,39 m	1,91 m	1,93 m	1	677 kg
	JIB SECTION - 5	10,56 m	1,91 m	1,93 m	1	1162 kg
	JIB SECTION - 6	10,63 m	1,91 m	2,07 m	1	1683 kg
	2-FALLS LINE HOIST BLOCK	1,32 m	0,53 m	1,09 m	1	634 kg
	4-FALLS LINE HOIST BLOCK	0,58 m	0,26 m	1,01 m	1	344 kg

TEREX CRANES

Tower Cranes

Via delle Innovazioni, 17
33074 Fontanafredda (PN)
Italy

Ph: +39 0434 989111
Email: info.cranes@terex.com

Rough Terrain Cranes

Via Cassoletta, 76 - Fraz. Crespellano
40053 Valsamoggia (BO)
Italy

Ph: +39 051 6501011
Email: info.cranes@terex.com

December 2019. Product specifications and prices are subject to change without notice or obligation. The photographs and/or drawings in this document are for illustrative purposes only. Refer to the appropriate Operator's Manual for instructions on the proper use of this equipment. Failure to follow the corresponding Operator's Manual when using our equipment or to otherwise act responsibly may result in serious injury or death. The only warranty applicable to our equipment is the standard written warranty applicable to the particular product and sale and Terex makes no other warranty, express or implied. Products and services listed may be trademarks, service marks or trade-names of Terex Corporation and/or its subsidiaries in the USA and other countries. All rights are reserved. Terex, the Terex Crown design and Works For You are trademarks of Terex Corporation or its subsidiaries.

Dicembre 2019. Specifiche e prezzi dei prodotti sono soggetti a modifica senza preavviso o altro obbligo. Le fotografie e i disegni in questo documento hanno esclusivamente scopo illustrativo. Consulta il Manuale dell'operatore pertinente per trovare istruzioni per l'utilizzo corretto di questo macchinario. La mancata osservanza delle istruzioni contenute nel relativo Manuale dell'operatore durante l'uso del macchinario e altri comportamenti irresponsabili possono provocare gravi lesioni, anche mortali. L'unica garanzia applicabile ai nostri macchinari è la garanzia scritta standard applicabile al particolare prodotto e alla particolare vendita e Terex è esonerata dal fornire qualsiasi altra garanzia, esplicita o implicita. I prodotti e servizi elencati possono essere dei marchi di fabbrica, marchi di servizio o nomi commerciali di Terex Corporation, e/o delle rispettive società affiliate negli Stati Uniti d'America e in molte altre nazioni. Tutti i diritti riservati. Terex, il marchio Terex Crown e Works for You sono marchi di proprietà di Terex Corporation o delle sue società affiliate.

Dezember 2019. Irrtum und Änderungen der Produktspezifikationen vorbehalten. Die in diesem Dokument enthaltenen Fotos und/oder Zeichnungen dienen rein anschaulichen Zwecken. Für den sachgemäßen Gebrauch der Maschinen ist das entsprechende Bedienerhandbuch heranzuziehen. Unsachgemäßer Umgang mit bzw. unsachgemäßer Einsatz unserer Maschinen kann zu schweren gesundheitlichen Schäden bis hin zum Tod führen. Für unsere Produkte wird ausschließlich die entsprechende, schriftlich niedergelegte Standardgarantie gewährt. Terex leistet keinerlei darüber hinausgehende Garantie, weder ausdrücklich noch stillschweigend. Die genannten Produkte und Dienstleistungen sind in den USA und anderen Ländern ggf. Marken, Dienstleistungsmarken oder Handelsnamen der Terex Corporation und/oder ihrer Tochtergesellschaften. Alle Rechte vorbehalten. Terex, das Terex Kronenlogo und Works For You sind Marken in Eigentum der Terex Corporation bzw. ihrer Tochtergesellschaften.

Décembre 2019. Les caractéristiques et prix des produits peuvent faire l'objet de modifications sans notification préalable. Les photographies ou dessins présentés dans ce document servent uniquement à des fins d'illustration. Pour connaître les instructions relatives à l'utilisation correcte de cet équipement, veuillez vous référer au manuel de l'utilisateur correspondant. Le non-respect du manuel d'utilisateur correspondant lors de l'utilisation de notre équipement ou des actes irresponsables risquent de provoquer de graves blessures, voire un décès. La seule garantie applicable à nos équipements est la garantie écrite standard applicable au produit et à la vente spécifiques. Terex ne délivre aucune autre garantie, expresse ou implicite. Les produits et les services mentionnés peuvent être des marques, des marques de service ou des appellations commerciales de Terex Corporation et/ou de ses filiales aux États-Unis et dans d'autres pays. Tous droits réservés. Terex, le design Terex Crown et Works For You sont des marques déposées de Terex Corporation ou de ses filiales.

Diciembre 2019. Las especificaciones y los precios de los productos están sujetos a cambios sin necesidad de previo aviso ni ninguna otra obligación. Las fotografías y/o dibujos de este documento tienen un fin meramente ilustrativo. Consulte el correspondiente manual de instrucciones del operario para obtener más información sobre el uso correcto de esta maquinaria. No respetar el manual del operario al utilizar la maquinaria o actuar de forma irresponsable puede provocar lesiones graves e incluso mortales. La única garantía aplicable a nuestra maquinaria es la garantía escrita estándar de cada producto y venta. Terex no amplía dicha garantía de forma expresa ni implícita. Los productos y servicios mencionados pueden ser marcas comerciales, marcas de servicio o nombres de marca de Terex Corporation o de alguna de sus filiales en Estados Unidos y otros países. Todos los derechos reservados. Terex, el diseño de la corona Terex y Works For You son marcas registradas de Terex Corporation o de sus filiales.

Dezembro 2019. Especificações e preços dos produtos sujeitos a alteração sem aviso prévio ou obrigações. As fotografias e/ou desenhos neste documento são apenas para fins ilustrativos. Consulte o respectivo Manual do Operador para instruções sobre o uso correto deste equipamento. Deixar de acompanhar o respectivo Manual do Operador ao usar o nosso equipamento ou, por qualquer outra forma, deixar de agir de maneira responsável pode resultar em lesões corporais graves ou a morte. A única garantia aplicável ao nosso equipamento é a garantia padrão por escrito correspondente ao produto específico vendido. A Terex não dá outras garantias, expressas ou implícitas. Os produtos e serviços listados podem ser marcas comerciais, marcas de serviço ou nomes-fantasia da Terex Corporation e/ou suas subsidiárias nos EUA e em outros países. Todos os direitos reservados. Terex, o desenho da Coroa Terex e a expressão Works For You são marcas comerciais da Terex Corporation ou suas subsidiárias.

декабрь 2019 г. года Технические характеристики и цены могут изменяться без предварительного уведомления и без каких-либо обязательств для производителя. Фотографии и (или) чертежи в настоящем документе служат только в качестве иллюстраций. Инструкции по надлежащей эксплуатации данного оборудования см. в соответствующем руководстве для оператора. Невыполнение указаний соответствующих руководств для оператора при эксплуатации оборудования или другие безответственные действия могут повлечь серьезные травмы или смерть. Единственной гарантией, действующей в отношении нашего оборудования, является стандартная форма письменной гарантии на данный тип оборудования и на условия его продажи. Terex не дает никаких других гарантий: ни ясно выраженных, ни подразумеваемых. Перечисленные продукты и услуги могут быть торговыми марками, знаками обслуживания или торговыми наименованиями Terex Corporation и / или ее дочерних компаний в США и других странах. Все права защищены. Terex, изображение короны Terex и Works for You являются торговыми марками, принадлежащими корпорации Terex или ее дочерним компаниям.



www.terex.com/cranes

Brochure Reference: TC-DS-M-E//G/F/S/P/R-CTL430-24-12/19



WORKS FOR YOU.™